



## RPT-2010G-2F-X4 Series

### Hardware User Manual

[www.sbjlink.com](http://www.sbjlink.com)

[sales@sbjlink.com](mailto:sales@sbjlink.com)

**Disclaimer**

Subject Link Inc. provides this manual without warranty of any kind, expressed or implied, including but not limited to the implied warranties of merchantability and fitness for a particular purpose. Subject Link Inc. may make improvements and/or changes to the product and/or specifications of the product described in this manual, without prior notice. Subject Link Inc. will not be liable for any technical inaccuracies or typographical errors found in this guide. Changes are periodically made to the information contained herein and will be incorporated into later versions of the manual. The information contained is subject to change without prior notice.

**FCC Notice**

This equipment has been tested and found to comply with the limits for a Class-A digital device, pursuant to Part 15 of the FCC rules. These limits are designed to provide reasonable protection against harmful interference in a residential installation. This equipment generates, uses, and can radiate radio frequency energy. It may cause harmful interference to radio communications if the equipment is not installed and used in accordance with the instructions. However, there is no guarantee that interference will not occur in a particular installation. If this equipment does cause harmful interference to radio or television reception, which can be determined by turning the equipment off and on, the user is encouraged to try to correct the interference by one or more of the following measures:

- Reorient or relocate the receiving antenna.
- Increase the separation between the equipment and receiver.
- Connect the equipment into an outlet on a circuit different from that to which the receiver is connected.
- Consult the dealer or an experienced radio/TV technician for help.

Caution: Any changes or modifications not expressly approved by the grantee of this device could void the user's authority to operate the equipment.

**CE Mark Warning**

This is a Class-A product. In a domestic environment this product may cause radio interference in which case the user may be required to take adequate measures.

This document is the current official release manual. Please check our website ([www.sbjlink.com](http://www.sbjlink.com)) for any updated manual or contact us by e-mail ([sales@sbjlink.com](mailto:sales@sbjlink.com)) .

# Contents

Overview.....	1
Software Features.....	1
Hardware Features .....	1
Package Contents.....	2
Safety Precaution.....	2
Hardware Description.....	4
Physical Dimensions.....	4
Front Panel.....	5
Top View.....	5
LED Indicators .....	6
Ethernet Ports.....	7
Cabling .....	8
Wiring the Power Inputs.....	10
Wiring the Fault Alarm Contact .....	11
Grounding Note .....	11
Mounting Installation .....	12
DIN-Rail Mounting .....	12
Wall Mounting .....	14
Hardware Installation .....	15
Installation Steps.....	15
Maintenance and Service .....	16
Trouble Shooting.....	17

# Overview

This series is rated IP30 and installation by DIN Rail. Each unit of this industrial gigabit managed Ethernet switch series has 8\* 10/100/1000TX Gigabit Ethernet ports and 2 dual-rate (100/1000) SFP slots, suitable for applications that require high bandwidth and long distance communication.

In order to prevent unregulated voltage, this series provides high EFT and ESD protection. This also allows it to function in harsh environments, as well as support power redundancy with a dual power input design with reverse polarity protection. The built-in relay warning function alerts users about occurring power failures.

With one model having an operating temperature of -10 to 65°C, and another with a wide operating temperature of -40 to 75°C, this series is designed to meet any needs for industrial automation, outdoor application and harsh environments.

## Software Features

Software Features	
Layer 3 Switching	Static Routes
Management	CLI, Http, Https, SNMP, SSH, Telnet
Security	Access Management, ACL, ARP Inspection, DHCP Snooping, IP Source Guard, Multiuser Account, Port Security Limit Control, RADIUS, TACACS+, 802.1Q VLAN, IP Subnet-based VLAN, MAC-based VLAN, Private VLAN, Protocol-based VLAN, GVRP
Green Ethernet	IEEE 802.3az EEE (Energy Efficient Ethernet)
Network Reliability	STP, RSTP, MSTP, ERPS (G.8032)
Multicast	IGMP snooping, MLD snooping, MVR
Traffic Control	LACP, QoS (CoS/ToS)
Monitor	LLDP, LLDP-MED, Port Mirroring, RMON, MIB, sFlow, Syslog Server
DHCP	DHCP Server/Client/Relay/Snooping
Other	ICMP Ping, ICMPv6 Ping, Loop Protection, Storm Protection, NTP Client
PoE Management (For PoE Models)	PoE Alive Check, PoE Power Budget Managed, PoE Scheduled

## Hardware Features

### Interface & Performance

- All Copper ports support auto MDI/MDI-X function
- Embedded 8\*10/100/1000Tx Gigabit Ethernet and 2\*100/1000 SFP Slots
- Store-and-forward switching architecture

- 8K MAC Address Table
- Supports 12.2Kbytes Jumbo Frame
- 4Mbits memory buffer

#### **Power Input**

- Redundant power DC 12~48V with connective 1\*6-pin removable terminal block
- Max. current 3.5A
- Relay Contact: 24 VDC, 1A resistive
- The power input specification is complied with the requirements of SELV (Safety Extra Low Voltage), and the power supply should be complied with UL 61010-1 & UL 61010-2-201

#### **Certification**

- CE/FCC
- UL 61010-1
- UL 61010-2-201

#### **Operating Temperature**

- Standard operating temperature model: -10°C ~ 65°C
- Extended operating temperature model (-T): -40°C ~ 75°C

#### **Case/Installation**

- IP-30 protection
- Installation in a Pollution Degree 2 industrial environment
- DIN-Rail and wall mount design

## **Package Contents**

- 1 – RPT-2010G-2F(-T)-X4: 10-port industrial gigabit managed Ethernet switch, with 8\*10/100/1000Tx Gigabit Ethernet, and 2\*100/1000 SFP slots
- 2 - Wall mounting brackets and screws
- 1 - RJ45 to DB9 Serial Console cable

## **Safety Precaution**

#### **Attention**

If the DC voltage is supplied by an external circuit, please use a protection device on the power supply input. The industrial Ethernet switch's hardware specs, ports, cabling information, and wiring installation will be described within this user manual.

#### **Warning Labels**

The caution label means that you should check the certain information on user manual when working with the device. (Shown in Figure 1.1)



Figure 1.1: Caution Label

This warning label is on the device, and means that the surface of the device is hot. (Shown in Figure 1.2)



Figure 1.2: Hot Surface Warning Label

# Hardware Description

## Physical Dimensions

Figure 2.1, below, shows the physical dimensions of RPT-2010G-2F-X4 series: 10-port industrial gigabit managed Ethernet switch with 8\*10/100/1000Tx Gigabit Ethernet, and 2\*100/1000 SFP slots.

(W x D x H) is 54mm x 99mm x 142mm

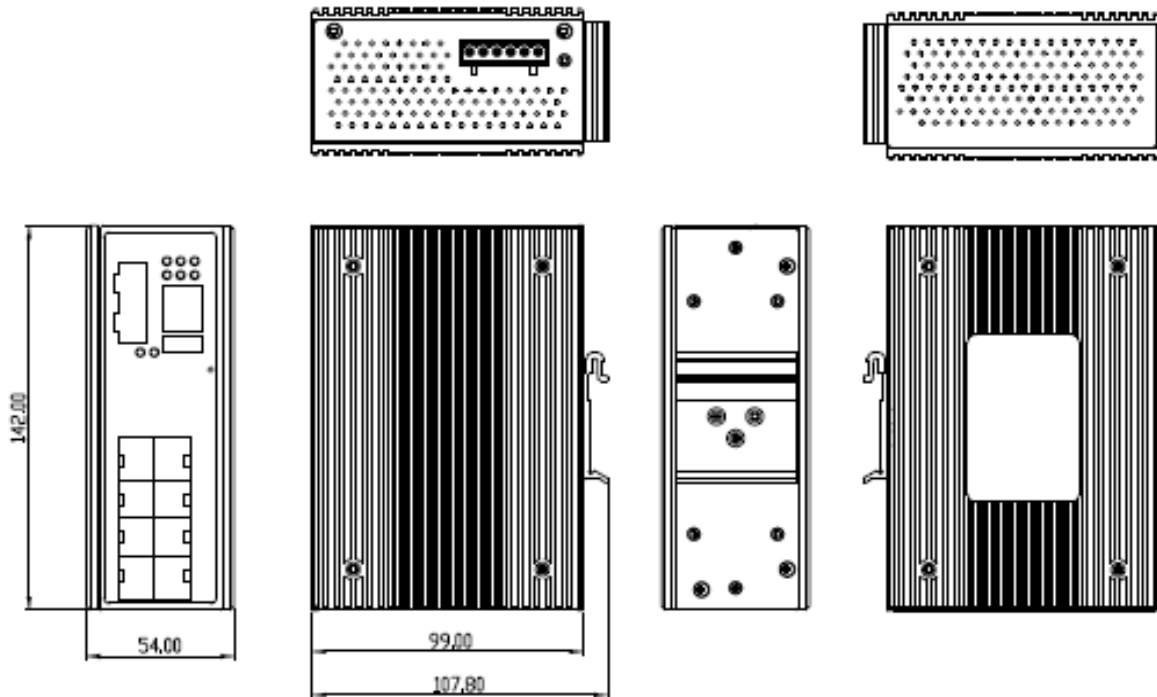

Figure 2.1: RPT-2010G-2F-X4 Series Physical Dimensions



## Front Panel

The front panel of the RPT-2010G-2F-X4 series industrial Gigabit managed Ethernet switch is shown below in Figure 2.2.

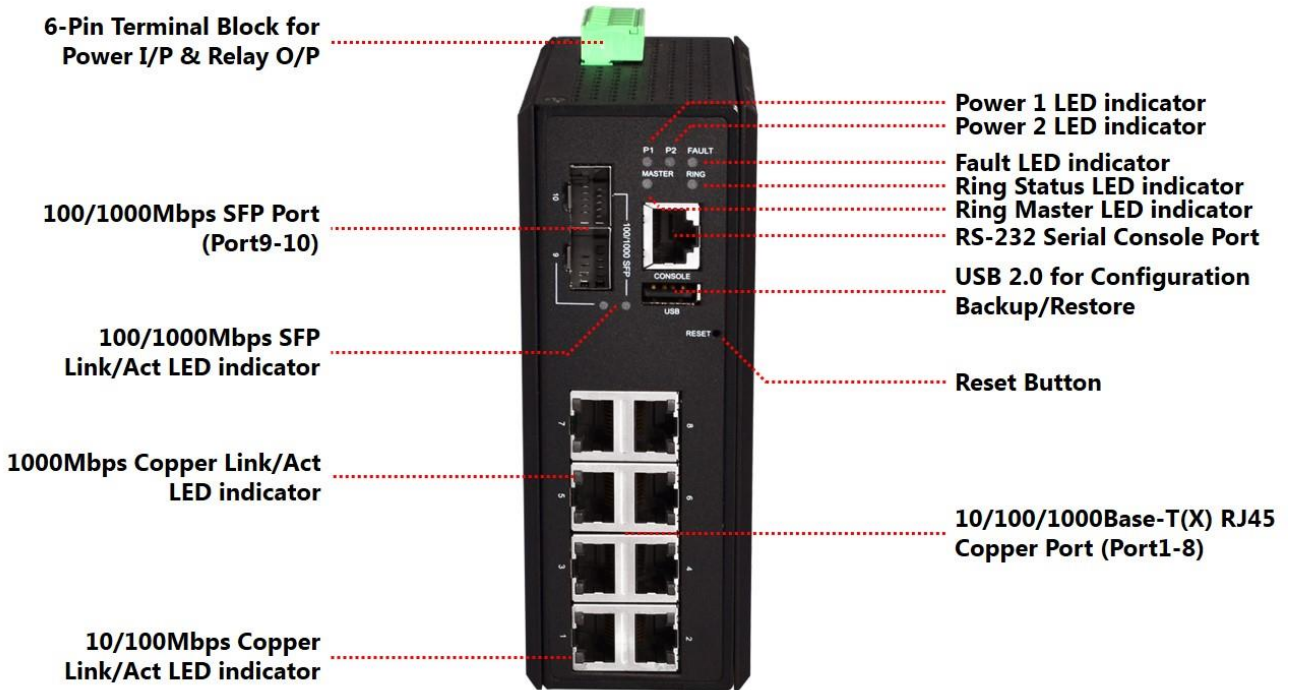

Figure 2.2: The Front Panel of RPT-2010G-2F-X4 Series

## Top View

Figure 2.3, below, shows the top panel of the RPT-2010G-2F-X4 series switch that is equipped with one 6-pin removal terminal block connector for dual DC power inputs (12~48VDC).

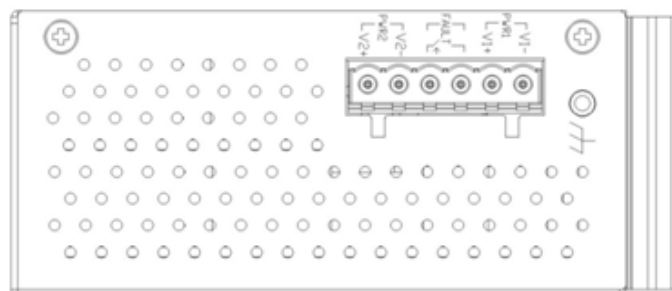

Figure 2.3: Top Panel View of RPT-2010G-2F-X4 Series

## LED Indicators

There are LED light indicators located on the front panel of the industrial Ethernet switch that display the power status and network status. Each LED indicator has a different color and has its own specific meaning, see below in Table 2.4.



LED	Color	Description	
P1	Green	On	Power input 1 is active
		Off	Power input 1 is inactive
P2	Green	On	Power input 2 is active
		Off	Power input 2 is inactive
FAULT	Green	On	No event happened
	Red	Off	1. Power input 1 or 2 is inactive 2. Port link-down/Broken
MASTER	Green	On	ERPS Owner Mode (Ring Master) is ready
		Off	ERPS Owner Mode is not active
RING	Green	On	ERPS Ring Network is active and works well
		Flashing	ERPS Ring works abnormally or misconfigure
		Off	ERPS Ring Network is not active
L/A (SFP Port 9-10)	Green	On	Connected to network, 1000Mbps
		Flashing	Networking is active
		Off	Not connected to network
	Amber	On	Connected to network, 100Mbps
		Flashing	Networking is active
		Off	Not connected to network
1G (LAN Port 1-8)		On	Connected to network, 1000Mbps
		Flashing	Networking is active
		Off	Not connected to network
10/100 (LAN Port 1-8)		On	Connected to network, 10/100Mbps
		Flashing	Networking is active
		Off	Not connected to network

Table 2.4: LED Indicators for RPT-2010G-2F-X4 Series

## Ethernet Ports

### RJ-45 Ports (Auto MDI/MDIX)

The RJ-45 ports are auto-sensing for 10Base-T, 100Base-TX or 1000Base-T devices connections. Auto MDI/MDIX means that the switch can connect to another switch or workstation without changing the straight-through or crossover cabling. See the figures as below for straight-through and crossover cabling schematics.

1 2 3 4 5 6 7 8

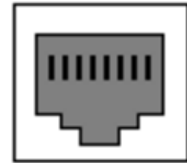

**RJ-45 Female**

### 10/100BASE-T(X) RJ-45 Pin Assignments (Table 2.5)

Crossover Cable		Straight Through Cable	
Pin Number / Signal	Pin Number / Signal	Pin Number / Signal	Pin Number / Signal
1 / RX+	3 / TX+	1 / RX+	1 / TX+
2 / RX-	6 / TX-	2 / RX-	2 / TX-
3 / TX+	1 / RX+	3 / TX+	3 / RX+
6 / TX-	2 / RX-	6 / TX-	6 / RX-

Table 2.5

### 1000BASE-T RJ-45 Pin Assignments (Table 2.6)

Crossover Cable		Straight Through Cable	
Pin Number / Signal	Pin Number / Signal	Pin Number / Signal	Pin Number / Signal
1 / TP0+	3 / TP1+	1 / TP0+	1 / TP1+
2 / TP0-	6 / TP1-	2 / TP0-	2 / TP1-
3 / TP1+	1 / TP0+	3 / TP1+	3 / TP0+
4 / TP2+	7 / TP3+	4 / TP2+	4 / TP3+
5 / TP2-	8 / TP3-	5 / TP2-	5 / TP3-
6 / TP1-	2 / TP0-	6 / TP1-	6 / TP0-
7 / TP3+	4 / TP2+	7 / TP3+	7 / TP2+
8 / TP3-	5 / TP2-	8 / TP3-	8 / TP2-

Table 2.6

**Note:** “+” and “-” signs represent the polarity of the wires that make up each wire pair.

## Cabling

Use the four twisted-pair, category 5e, or the above cabling for RJ-45 port connections. The cable between the switch and the link partner (switch, hub, workstation, etc.) must be less than 100 meters (328 ft.) long.

The small form-factor pluggable (SFP) is a compact optical transceiver used in optical communications for both telecommunication and data communication applications.



**Caution:** Please employ optional optical transceiver (SFP/Fixed Fiber) that complies with IEC 60825-1 and classified as Class 1 laser product.

To connect the transceiver and LC cable, please follow below steps:

**Step 1** Insert the SFP transceiver module into the SFP slot as shown below in Figure 2.7. Notice that the triangle mark is at the bottom of the SFP slot. Figure 2.8 shows SFP transceiver module was inserted.

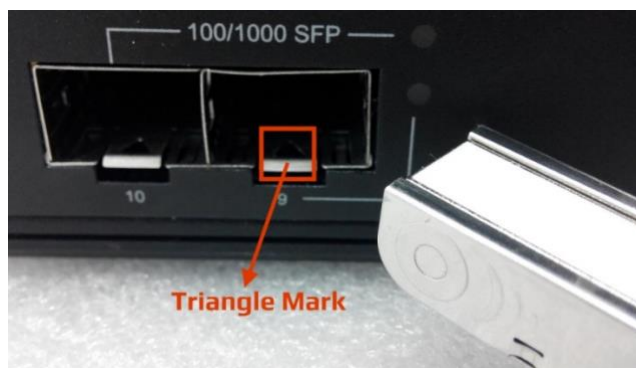

Figure 2.7: Transceiver to the SFP Module

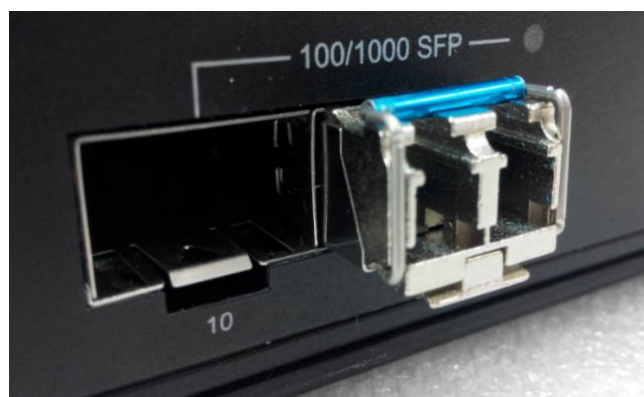

Figure 2.8: Transceiver Inserted

Step 2 Insert the fiber cable of the LC connector into the transceiver as shown below in Figure 2.9.



Figure 2.9: LC Connector to the Transceiver

To remove the LC connector from the transceiver, please follow the steps shown below:

Step 1 Press the upper side of the LC connector from the transceiver and pull it out to release as shown below in Figure 2.4



Figure 2.4: Remove LC Connector

Step 2 Push down the metal clasp and pull the transceiver out by the plastic part as shown below in Figure 2.5

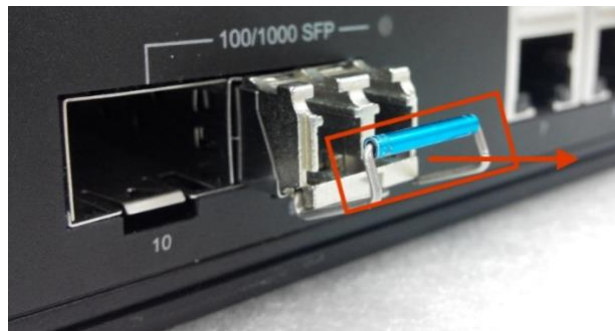

Figure 2.5: Pull Out from the SFP Module

## Wiring the Power Inputs



**Caution:** Please follow the below steps to insert the power wire.

- Step 1 Insert the positive and negative wires into the PWR1 (V1+, V1-) and PWR2 (V2+, V2-) contacts on the terminal block connector as shown below in Figure 2.6.



Figure 2.6: Power Terminal Block

- Step 2 Tighten the wire-clamp screws to prevent the wires from loosening, as shown below in Figure 2.7.



Figure 2.7: Power Terminal Block



**Caution:** Only use copper conductors, 100°C, tighten to 5 in-lbs.

The wire gauge for the terminal block should range between 18~20 AWG.

## Wiring the Fault Alarm Contact

The fault alarm contact is in the middle of the terminal block connector as the picture shows below in Figure 2.8. By inserting the wires, it will detect the fault status including power failure or port link failure (managed industrial switch only) and form a normally open circuit. An application example for the fault alarm contact is shown below in Figure 2.8.

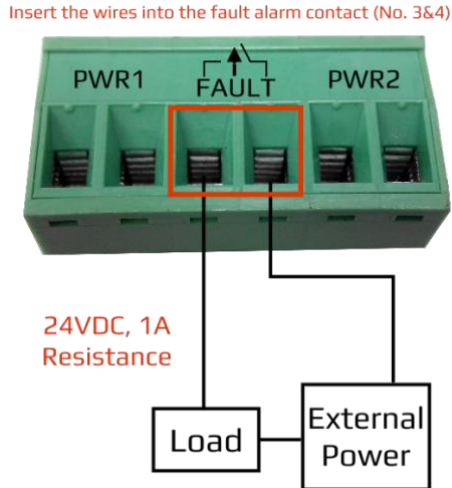

Figure 2.8: Wiring the Fault Alarm Contact



**Caution:** The wire gauge for the terminal block should range between 12 ~ 24 AWG.

If only using one power source, jumper Pin 1 to Pin 5 and Pin 2 to Pin 6 to eliminate power fault alarm.

## Grounding Note

Grounding and wire routing help limit the effects of noise due to electromagnetic interference (EMI). Run the ground connection from the ground screw to the grounding surface prior to connecting devices. The grounding screw symbol is shown below in Figure 2.15.



Figure 2.15: Grounding screw



**Caution:** Using a shielded cable achieves better electromagnetic compatibility.

# Mounting Installation

## DIN-Rail Mounting

The DIN-Rail is pre-installed on the industrial Ethernet switch from the factory. If the DIN-Rail is not on the industrial Ethernet switch, please see Figure 3.1 to learn how to install the DIN-Rail on the switch.

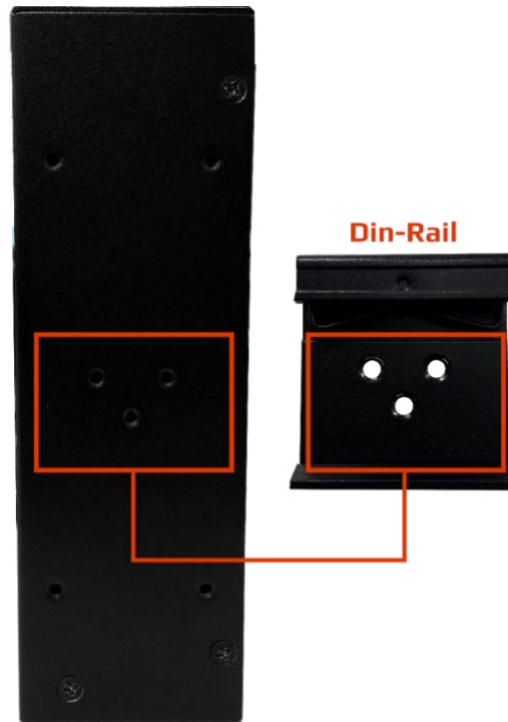

Figure 3.1: The Rear Side of the Switch and DIN-Rail Bracket

Follow the steps below to learn how to hang the industrial Ethernet switch.

Step 1 Use the screws to install the DIN-Rail bracket on the rear side of the industrial Ethernet switch.



**Caution:** The torque for tightening the screws on the device is 3.5 in-lbs.

Step 2 To remove the DIN-Rail bracket, do the opposite from Step 1.

Step 3 After the DIN-Rail bracket is installed on the rear side of the switch, insert the top of the DIN-Rail on to the track as shown below in Figure 3.2.



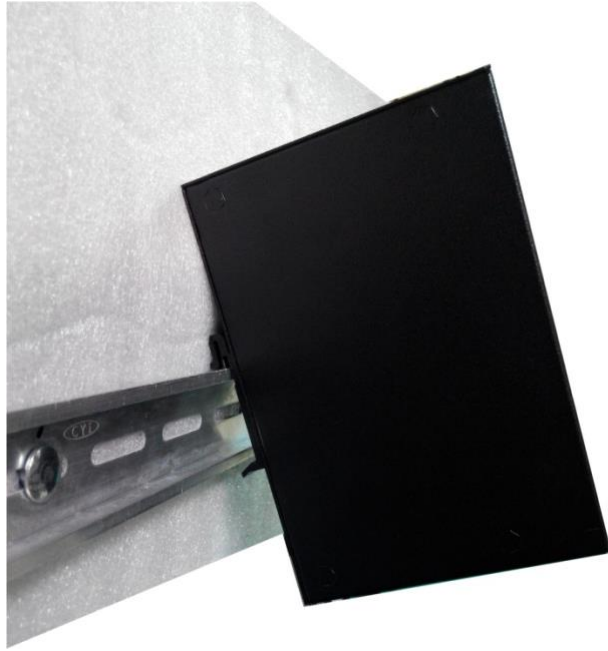

Figure 3.2: Insert the Switch on the DIN-Rail

Step 4 Lightly pull down the bracket on to the rail as shown below in Figure 3.3.



Figure 3.3: Stable the Switch on DIN-Rail

Step 5 Check if the bracket is mounted tightly on the rail.

Step 6 To remove the industrial Ethernet switch from the rail, do the opposite from the above steps.

## Wall Mounting

Follow the steps below to mount the industrial Ethernet switch using the wall mounting bracket as shown below in Figure 3.4.



**Caution:** “Wall” means industrial control panel wall.

- Step 1 Remove the DIN-Rail bracket from the industrial Ethernet switch by loosening the screws.
- Step 2 Place the wall mounting brackets on the top and bottom of the industrial Ethernet switch.
- Step 3 Use the screws to screw the wall mounting bracket on the industrial Ethernet switch.
- Step 4 Use the hook holes at the corners of the wall mounting bracket to hang the industrial Ethernet switch on the wall.
- Step 5 To remove the wall mount bracket, do the opposite from the steps above.



Figure 3.4: Remove DIN-Rail Bracket from the Switch

Below, in Figure 3.5 are the dimensions of the wall mounting bracket.

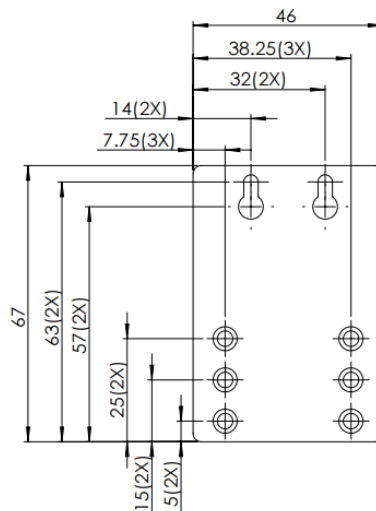

Figure 3.5: Wall Mounting Bracket Dimensions

# Hardware Installation

---

## Installation Steps

This section will explain how to install RPT-2010G-2F-X4 series: 10-port industrial gigabit managed Ethernet switch with 8\*10/100/1000Tx Gigabit Ethernet, and 2\*100/1000 SFP slots.



**Caution:** This device is intended for use indoor and at altitudes up to 2000 meters.



**Caution:** The device is intended to be installed in an industrial control enclosure and panel

### Installation Steps

- Step 1 Unpack the industrial Ethernet switch from the original packing box.
- Step 2 Check if the DIN-Rail bracket is screwed on the industrial Ethernet switch.
  - If the DIN-Rail is not screwed on the industrial Ethernet switch, please refer to the **DIN-Rail Mounting** section for DIN-Rail installation.
  - If you want to wall mount the industrial Ethernet switch, please refer to the **Wall Mounting** section for wall mounting installation.
- Step 3 To hang the industrial Ethernet switch on a DIN-Rail or wall, please refer to the **Mounting Installation** section.
- Step 4 Power on the industrial Ethernet switch and then the power LED light will turn on.
  - If you need help on how to wire power, please refer to the **Wiring the Power Inputs** section.
  - Please refer to the **LED Indicators** section for LED light indication.
- Step 5 Prepare the twisted-pair, straight-through category 5 cable for Ethernet connection.
- Step 6 Insert one side of the RJ-45 cable into switch's Ethernet port and on the other side into the networking device's Ethernet port, e.g. switch PC or server. The Ethernet port's (RJ-45) LED on the industrial Ethernet switch will turn on when the cable is connected to the networking device.
  - Please refer to the **LED Indicators** section for LED light indication.
- Step 7 When all connections are set and the LED lights all show normal, the installation is complete.

# Maintenance and Service

---

- If the device requires servicing of any kind, the user is required to disconnect and remove it from its mounting. The initial installation should be done in a way that makes this as convenient as possible.
- Voltage/Power lines should be properly insulated as well as other cables. Be careful when handling them so as to not trip over.
- Do not under any circumstance insert foreign objects of any kind into the heat dissipation holes located in the different faces of the device. This may not only harm the internal layout, but might cause harm to user as well.
- Do not under any circumstance open the device for any reason. Please contact your dealer for any repair needed or follow the instructions within the manual.
- Clean the device with dry soft cloth.

# Trouble Shooting

---

- Verify you have the right power cord or adapter. Never use a power supply or adapter with a non-compliant DC output voltage or it will burn the equipment.
- Select the proper UTP or STP cable in order to construct the network. Use an unshielded twisted-pair (UTP) or shield twisted-pair (STP) cable for RJ-45 connections: 100Ω Category 5e for 10M/100Mbps. Also be sure that the length of any twisted-pair connection does not exceed 100 meters (328 feet).
- Diagnosing LED Indicators: To assist in identifying problems, the switch can be easily monitored with the LED indicators which help to identify if any problems exist.
  - ◆ Please refer to the LED Indicators section for LED light indication.
- If the power indicator LED does not turn on when the power cord is plugged in, the user may have a problem with the power cord. Check for loose power connections, power losses or surges at the power outlet.
  - ◆ Please contact Sbjlink for technical support service, if the problem still cannot be resolved.
- If the industrial switch LED indicators are normal and the connected cables are correct but the packets still cannot transmit, please check the system's Ethernet devices' configuration or status.