



RPT-1008-X4 Series

Hardware User Manual

www.sbjlink.com

sales@sbjlink.com

Disclaimer

Subject Link Inc. provides this manual without warranty of any kind, expressed or implied, including but not limited to the implied warranties of merchantability and fitness for a particular purpose. Subject Link Inc. may make improvements and/or changes to the product and/or specifications of the product described in this manual, without prior notice. Subject Link Inc. will not be liable for any technical inaccuracies or typographical errors found in this guide. Changes are periodically made to the information contained herein and will be incorporated into later versions of the manual. The information contained is subject to change without prior notice.

FCC Notice

This equipment has been tested and found to comply with the limits for a Class-A digital device, pursuant to Part 15 of the FCC rules. These limits are designed to provide reasonable protection against harmful interference in a residential installation. This equipment generates, uses, and can radiate radio frequency energy. It may cause harmful interference to radio communications if the equipment is not installed and used in accordance with the instructions. However, there is no guarantee that interference will not occur in a particular installation. If this equipment does cause harmful interference to radio or television reception, which can be determined by turning the equipment off and on, the user is encouraged to try to correct the interference by one or more of the following measures:

- Reorient or relocate the receiving antenna.
- Increase the separation between the equipment and receiver.
- Connect the equipment into an outlet on a circuit different from that to which the receiver is connected.
- Consult the dealer or an experienced radio/TV technician for help.

Caution: Any changes or modifications not expressly approved by the grantee of this device could void the user's authority to operate the equipment.

Déclaration FCC

Cet équipement a été testé et reconnu conforme aux limites de la classe A pour les équipements numériques, conformément à la section 15 des Réglementations FCC. Ces limites sont conçues pour fournir une protection raisonnable contre toutes interférences nuisibles dans un milieu résidentiel. Cet équipement génère, utilise, et peut émettre de l'énergie de fréquence radio et, s'il n'est pas installé et utilisé conformément au manuel d'instruction, peut perturber la réception radio. Cependant, il n'est pas garanti que l'équipement ne produira aucune interférence dans une installation particulière. Si cet équipement cause des interférences nuisibles à la réception radio ou télévisée, qui peuvent être déterminées en l'éteignant et le rallumant, l'utilisateur est encouragé à essayer de remédier au problème en prenant les mesures suivantes:

- Réorienter ou déplacer l'antenne réceptrice.
- Augmenter la distance entre l'équipement et le récepteur.
- Connecter l'équipement à une prise secteur sur un circuit différent de celui utilisé par le récepteur.
- Consulter le négociant ou un technicien radio/TV expérimenté.

Attention: Tout changement ou modification non expressément approuvé par le concessionnaire de cet appareil pourrait annuler l'autorité de l'utilisateur à utiliser l'équipement.

CE Mark Warning

This is a Class-A product. In a domestic environment this product may cause radio interference in which case the user may be required to take adequate measures.

CE Mark Avertissement

Ceci est un produit de classe A. Dans un environnement domestique, ce produit peut être utilisé en présence d'interférences radio.

This document is the current official release manual. Please check our website (www.sbjlink.com) for any updated manual or contact us by e-mail (sales@sbjlink.com).

CONTENT

OVERVIEW	5
Key Features.....	5
Package Contents.....	6
Safety Precaution.....	6
HARDWARE DESCRIPTION	7
Physical Dimensions	7
Front Panel	8
Top View.....	8
LED Indicators.....	9
Ethernet Ports.....	10
Cabling.....	11
Wiring the Power Inputs.....	11
Wiring the Fault Alarm Contact.....	12
Grounding Note.....	12
MOUNTING INSTALLATION	13
DIN-Rail Mounting.....	13
Wall Mounting.....	15
HARDWARE INSTALLATION	16
Installation Steps	16
TROUBLE SHOOTING	18

OVERVIEW

This series is rated IP30 and installation by DIN Rail. Each unit of this industrial unmanaged Ethernet switch series has 8*10/100Tx Fast Ethernet ports, which the RJ-45 interface provides auto-detection of MDI or MDI-X.

In order to prevent unregulated voltage, this series provides high EFT and ESD protection. This also allows it to function in harsh environments, as well as support power redundancy with a dual power input design with reverse polarity protection. The built-in relay warning function alerts users about occurring power failures.

With one model having an operating temperature of -10°C ~ 65°C, and another with a wide operating temperature of -40°C ~ 75°C, this series is designed to meet the needs for industrial automation application and harsh environments.

Key Features

Interface & Performance

- All Copper ports support auto MDI/MDI-X function
- Embedded 8*10/100Tx Fast Ethernet
- Store-and-forward switching architecture
- 2K MAC Address Table
- 448Kbits memory buffer

Power Input

- Dual 12-48VDC redundant power inputs
- 1 removable 6-contact terminal block
- Max. current 0.28A
- Relay Contact: 24VDC, 1A resistive
- The power input specification is complied with the requirements of SELV (Safety Extra Low Voltage), and the power supply should be complied with UL 61010-1 & UL 61010-2-201.

Certification

- CE/FCC
- UL 61010-1
- UL 61010-2-201

Operating Temperature

- Standard operating temperature model: -10°C ~ 65°C
- Extended operating temperature model (-T): -40°C ~ 75°C

Case/Installation

- IP30 protection
- Installation in a pollution degree 2 industrial environment
- DIN-Rail and wall mount design

Package Contents

- 1 – RPT-1008-X4 - Unit weight: 0.45 kg (0.99 lbs.), Shipping weight: 0.65 kg (1.43 lbs.)
- 2 - Wall mounting brackets and screws
- 1 - Quick installation guide

Safety Precaution

Attention

If the DC voltage is supplied by an external circuit, please use a protection device on the power supply input. Supply by UL Listed industrial use power. The industrial Ethernet switch's hardware specs, ports, cabling information, and wiring installation will be described within this user manual.

Attention

Si la tension CC est fournie par un circuit externe, veuillez utiliser un dispositif de protection sur l'entrée d'alimentation. Fourniture par courant industriel homologué UL. Les spécifications matérielles, les ports, les informations de câblage et l'installation du câblage du convertisseur de média industriel seront décrits dans ce manuel d'utilisation.

Warning Labels

The caution label means that you should check the certain information on user manual when working with the device. (Shown in *Figure 1.1*)

Étiquettes d'avertissement

L'étiquette d'avertissement signifie que vous devez vérifier certaines informations sur le manuel d'utilisation lorsque vous travaillez avec l'appareil. (Montré dans la *Figure 1.2*)



Figure 1.1 - Caution Label
Figure 1.1 - Étiquette de mise en garde



Figure 1.2 - Hot Surface Warning Label
Figure 1.2 - Étiquette d'avertissement de surface chaude

HARDWARE DESCRIPTION

Physical Dimensions

Figure 2.1, below, shows the physical dimensions of RPT-1008-X4 series.

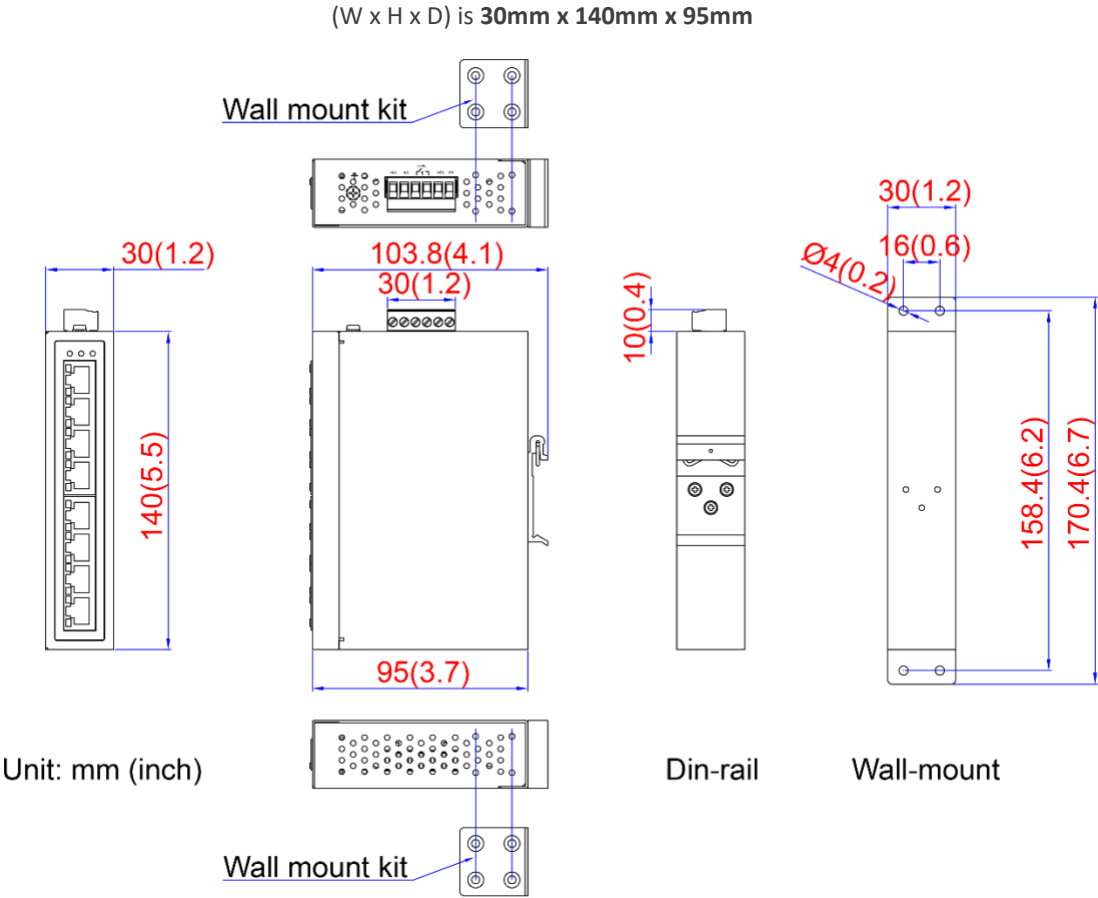

Figure 2.1: Physical Dimensions

Front Panel

The front panel of the RPT-1008-X4 series industrial unmanaged Ethernet switch is shown below in Figure 2.2.

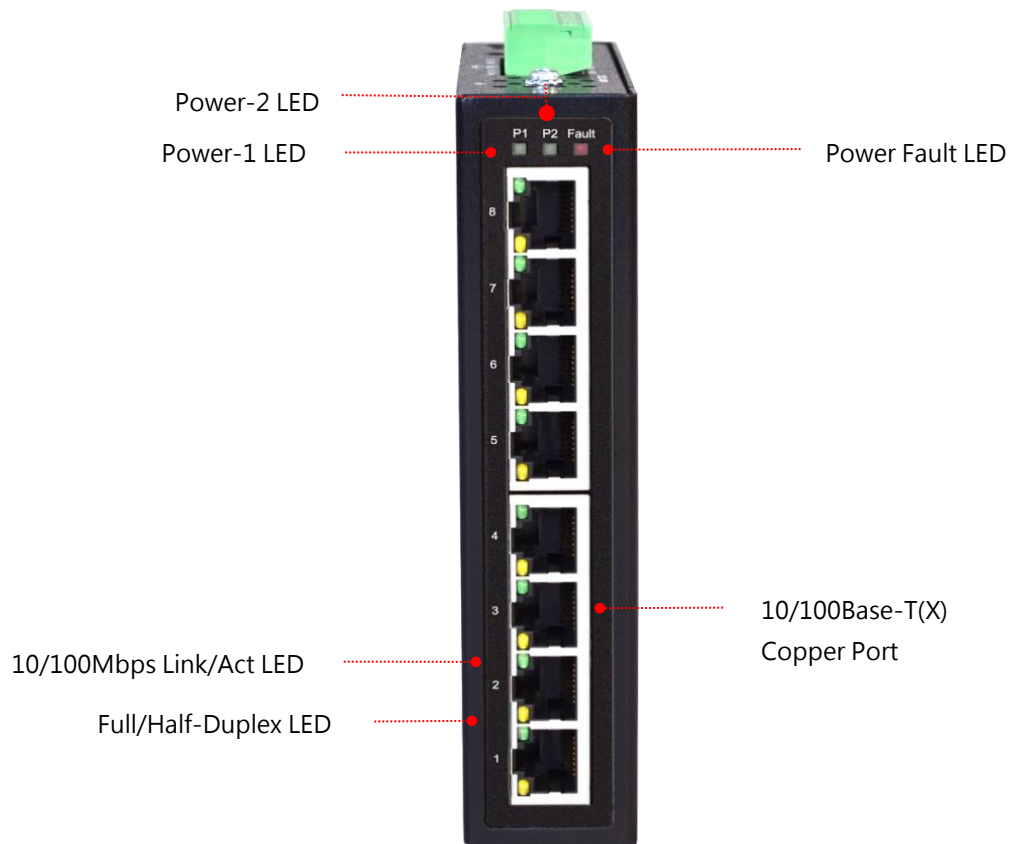

Figure 2.2: The Front Panel

Top View

Figure 2.3, below, shows the top panel of the RPT-1008-X4 series switches that is equipped with one 6-pin removal terminal block connectors for dual DC power inputs (12-48VDC).

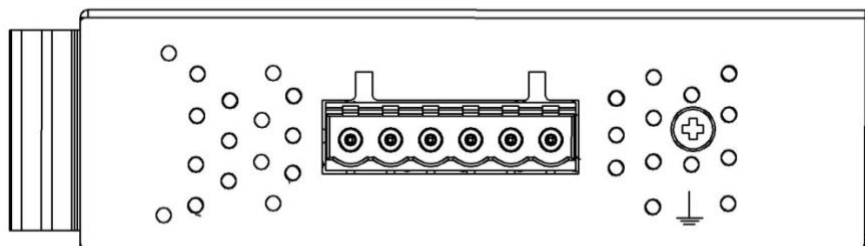

Figure 2.3: Top Panel View

LED Indicators

There are LED light indicators located on the front panel of the industrial switch that display the power status and network status. Each LED indicator has a different color and has its own specific meaning, see below in Table 2.1.



LED	Color	Description	
P1	Green	On	Power input 1 is active
		Off	Power input 1 is inactive
P2	Green	On	Power input 2 is active
		Off	Power input 2 is inactive
Fault	Red	On	Power input 1 or 2 is inactive
		Off	Power input 1 and 2 are both functional
LAN Port LINK/ACT/SPEED	Green 	On	Connected to network
		Flashing	Networking is active
		Off	Not connected to network
	Amber 	On	Ethernet port full duplex
		Flashing	Collision of packets occurs
		Off	Not connected to network

Table 2.1: LED Indicators

Ethernet Ports

RJ-45 Ports (Auto MDI/MDIX)

The RJ-45 ports are auto-sensing for 10Base-T, 100Base-TX or 1000Base-T devices connections. Auto MDI/MDIX means that the switch can connect to another switch or workstation without changing the straight-through or crossover cabling. See the figures as below for straight-through and crossover cabling schematics.

1 2 3 4 5 6 7 8

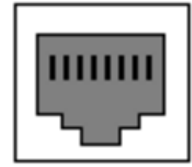

RJ-45 Female

10/100BASE-T(X) RJ-45 Pin Assignments (Table 2.2)

Crossover Cable		Straight Through Cable	
Pin Number / Signal	Pin Number / Signal	Pin Number / Signal	Pin Number / Signal
1 / RX+	3 / TX+	1 / RX+	1 / TX+
2 / RX-	6 / TX-	2 / RX-	2 / TX-
3 / TX+	1 / RX+	3 / TX+	3 / RX+
6 / TX-	2 / RX-	6 / TX-	6 / RX-

Table 2.2

1000BASE-T RJ-45 Pin Assignments (Table 2.3)

Crossover Cable		Straight Through Cable	
Pin Number / Signal	Pin Number / Signal	Pin Number / Signal	Pin Number / Signal
1 / TP0+	3 / TP1+	1 / TP0+	1 / TP1+
2 / TP0-	6 / TP1-	2 / TP0-	2 / TP1-
3 / TP1+	1 / TP0+	3 / TP1+	3 / TP0+
4 / TP2+	7 / TP3+	4 / TP2+	4 / TP3+
5 / TP2-	8 / TP3-	5 / TP2-	5 / TP3-
6 / TP1-	2 / TP0-	6 / TP1-	6 / TP0-
7 / TP3+	4 / TP2+	7 / TP3+	7 / TP2+
8 / TP3-	5 / TP2-	8 / TP3-	8 / TP2-

Table 2.3

Note: “+” and “-” signs represent the polarity of the wires that make up each wire pair.

Cabling

Use the two/four twisted-pair, category 5e, or the above cabling for RJ-45 port connections. The cable between the switch and the link partner (switch, hub, workstation, etc.) must be less than 100 meters (328 ft.) long.

Wiring the Power Inputs



Caution: Please follow the below steps to insert the power wire.



Attention: Veuillez suivre les étapes ci-dessous pour insérer le câble d'alimentation.

Step 1 Insert the positive and negative wires into the PWR1 (V1+, V1-) and PWR2 (V2+, V2-) contacts on the terminal block connector as shown below in Figure 2.4.

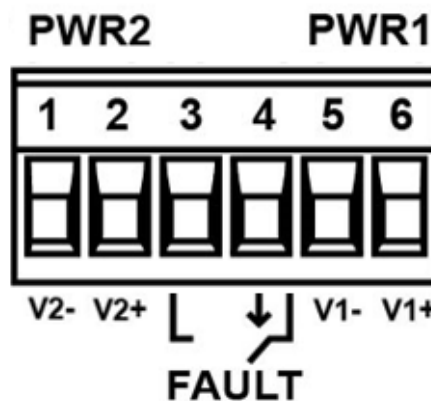

Figure 2.4: Power Terminal Block

Step 2 Tighten the wire-clamp screws to prevent the wires from loosening, as shown below in Figure 2.5.

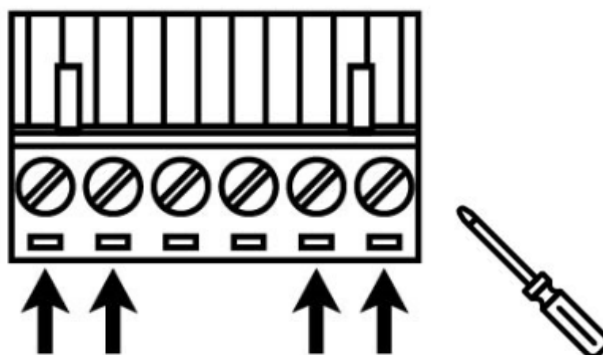

Figure 2.5: Power Terminal Block



Caution: Only use copper conductors, 125°C, tighten to 7 in-lbs (0.79 Nm). The wire gauge for the terminal block should range between 18~20 AWG.



Attention: Utilisez uniquement des conducteurs en cuivre, 125 ° C, serrer à 7 in-lbs (0,79 Nm). Le calibre des fils du bornier doit être compris entre 18 et 20 AWG.

Wiring the Fault Alarm Contact

The fault alarm contact is in the middle of the terminal block connector as the picture shows below in Figure 2.7. By inserting the wires, it will detect the fault status including power failure or port link failure (managed industrial switch only) and form a normally open circuit. An application example for the fault alarm contact is shown below in Figure 2.6.

Insert the wires into fault alarm contact (Pin 3 & 4)

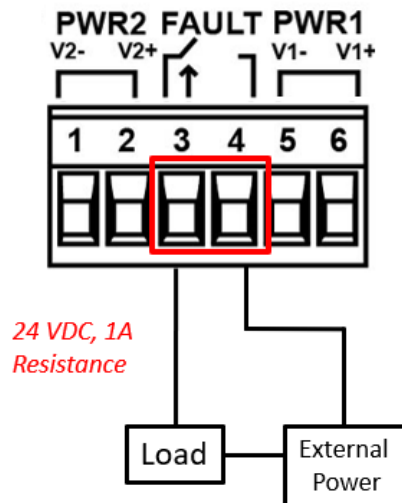

Figure 2.6: Wiring the Fault Alarm Contact

Grounding Note

Grounding and wire routing help limit the effects of noise due to electromagnetic interference (EMI). Run the ground connection from the ground screw to the grounding surface prior to connecting devices. The grounding screw symbol is shown below in Figure 2.7.

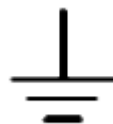

Figure 2.7: Grounding screw symbol



Caution: Using a shielded cable achieves better electromagnetic compatibility.



Attention: L'utilisation d'un câble blindé permet une meilleure compatibilité électromagnétique.

MOUNTING INSTALLATION

DIN-Rail Mounting

The DIN-Rail is pre-installed on the industrial Ethernet Switch from the factory. If the DIN-Rail is not on the industrial Ethernet Switch, please see Figure 3.1 to learn how to install the DIN-Rail on the Switch.



Figure 3.1: The Rear Side of the Switch and Wall Mounting Bracket

Follow the steps below to learn how to hang the industrial Ethernet switch.

- Step 1 Use the screws to install the DIN-Rail bracket on the rear side of the industrial Ethernet switch.
- Step 2 To remove the DIN-Rail bracket, do the opposite from Step 1.
- Step 3 After the DIN-Rail bracket is installed on the rear side of the switch, insert the top of the DIN-Rail on to the track as shown below in Figure 3.2.

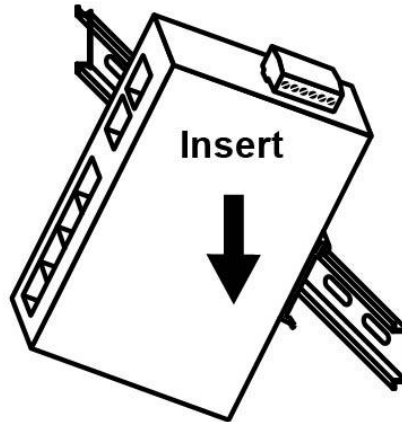

Figure 3.2: Insert the Switch on the DIN-Rail

- Step 4 Lightly pull down the bracket on to the rail as shown below in Figure 3.3.

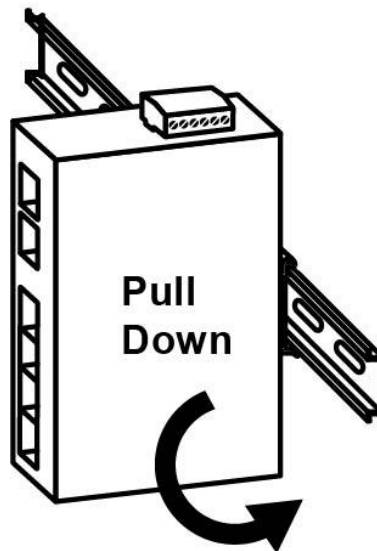

Figure 3.3: Stable the Switch on DIN-Rail

- Step 5 Check if the bracket is mounted tightly on the rail.
- Step 6 To remove the industrial Ethernet switch from the rail, do the opposite from the above steps.

Wall Mounting

Follow the steps below to mount the industrial Ethernet switch using the wall mounting bracket as shown below in Figure 3.4.

- Step 1. Remove the DIN-Rail bracket from the industrial Ethernet switch by loosening the screws.
- Step 2. Place the wall mounting brackets on the top and bottom of the industrial Ethernet switch.
- Step 3. Use the screws to screw the wall mounting bracket on the industrial Ethernet switch.
- Step 4. Use the hook holes at the corners of the wall mounting bracket to hang the industrial Ethernet switch on the wall.
- Step 5. To remove the wall mount bracket, do the opposite from the steps above.

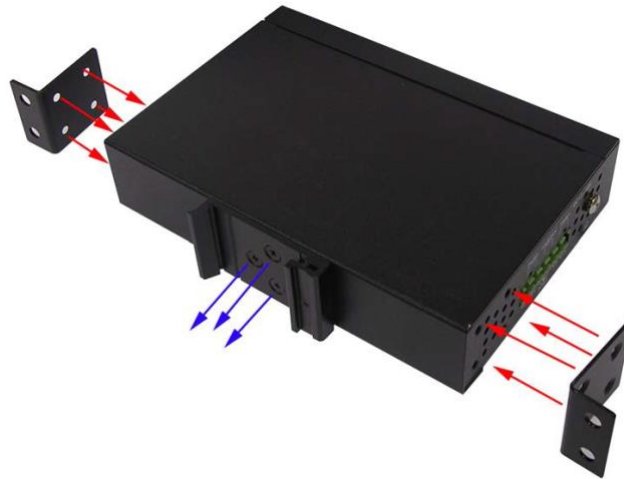

Figure 3.4: Remove DIN-Rail Bracket from the Switch and Install the Wall Mount Bracket

Below, in Figure 3.5 are the dimensions of the wall mounting bracket.

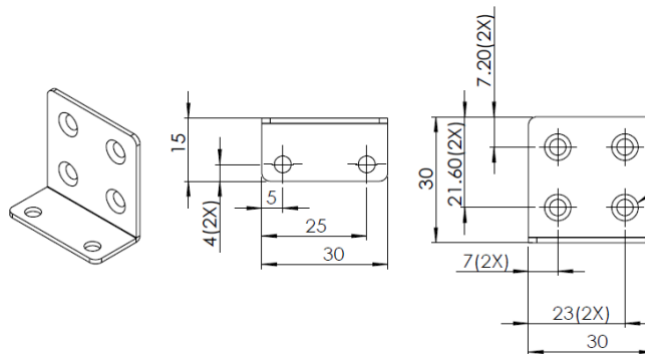

Figure 3.5: Wall Mounting Bracket Dimensions

HARDWARE INSTALLATION

Installation Steps

This section will explain how to install RPT-1008-X4 series.

Installation Steps

Step 1. Unpack the industrial Switch from the original packing box.

Step 2. Check if the DIN-Rail bracket is screwed on the industrial Switch.

- If the DIN-Rail is not screwed on the industrial Switch, please refer to the **DIN-Rail Mounting** section for DIN-Rail installation.
- If you want to wall mount the industrial Switch, please refer to the **Wall Mounting** section for wall mounting installation.

Step 3. To hang the industrial Switch on a DIN-Rail or wall, please refer to the **Mounting Installation** section.

Step 4. Power on the industrial Switch and then the power LED light will turn on.

- If you need help on how to wire power, please refer to the **Wiring the Power Inputs** section.
- Please refer to the **LED Indicators** section for LED light indication.

Step 5. Prepare the twisted-pair, straight-through category 5 cable for Ethernet connection.

Step 6. Insert one side of the RJ-45 cable into Switch's Ethernet port and on the other side into the networking device's Ethernet port, e.g. switch PC or server. The Ethernet port's (RJ-45) LED on the industrial Switch will turn on when the cable is connected to the networking device.

- Please refer to the **LED Indicators** section for LED light indication.

Step 7. When all connections are set and the LED lights all show normal, the installation is complete.



Caution: If the equipment is used in a manner not specified by the manufacturer, the protection provided by the equipment may be impaired.



Attention: Si l'équipement est utilisé d'une manière non spécifiée par le fabricant, la protection fournie par l'équipement peut être altérée.



Caution: The installation that the safety to any system incorporating the equipment is the responsibility of the assembler of the system.



Attention: L'installation que la sécurité de tout système intégrant l'équipement est de la responsabilité de l'assembleur du système.



Caution: This is an OPEN TYPE module and should be installed in a final safety enclosure characteristic.



Attention: Il s'agit d'un module de TYPE OUVERT et doit être installé dans une caractéristique finale d'enceinte de sécurité.



Caution: This device is intended for use indoor and at altitudes up to 2000 meters.



Attention: Cet appareil est destiné à être utilisé en intérieur et à des altitudes allant jusqu'à 2000 mètres.



Caution: Ambient Relative Humidity should be within the range of 5 and 95% (non-condensing).



Attention: L'humidité relative ambiante doit être comprise entre 5 et 95% (sans condensation).

TROUBLE SHOOTING

- Verify you have the right power cord or adapter. Never use a power supply or adapter with a non-compliant DC output voltage or it will burn the equipment.
- Select the proper UTP or STP cable in order to construct the network. Use an unshielded twisted-pair (UTP) or shield twisted-pair (STP) cable for RJ-45 connections: 100Ω Category 5e for 10M/100Mbps. Also be sure that the length of any twisted-pair connection does not exceed 100 meters (328 feet).
- Diagnosing LED Indicators: To assist in identifying problems, the switch can be easily monitored with the LED indicators which help to identify if any problems exist.
 - ◆ Please refer to the LED Indicators section for LED light indication.
- If the power indicator LED does not turn on when the power cord is plugged in, the user may have a problem with the power cord. Check for loose power connections, power losses or surges at the power outlet.
 - ◆ Please contact Sbjlink for technical support service, if the problem still cannot be resolved.
- If the industrial switch LED indicators are normal and the connected cables are correct but the packets still cannot transmit, please check the system's Ethernet devices' configuration or status.